

Solid State Relay

KSI240 Series Single Phase AC Output



- Zero switching or random-on
- Ratings from 10A to 100A @ 48-280VAC
- Triac or SCR output for heavy industrial loads
- AC or DC input
- Superior thermal performance
- Dielectric strength 4000VACrms
- LED indication
- Internal RC/MOV and TVS protection circuit as option

Product Description

KSI240 series industrial single phase relay with triac or SCR output is the most widely used in industry application. The relay can be used for resistive, inductive and capacitive loads. The control input voltage is 4-32VDC or 90-280VAC, output current rate 10A, 25A, 40A, 60A, 80A, 100A @ 48-280VAC.

Product Selection

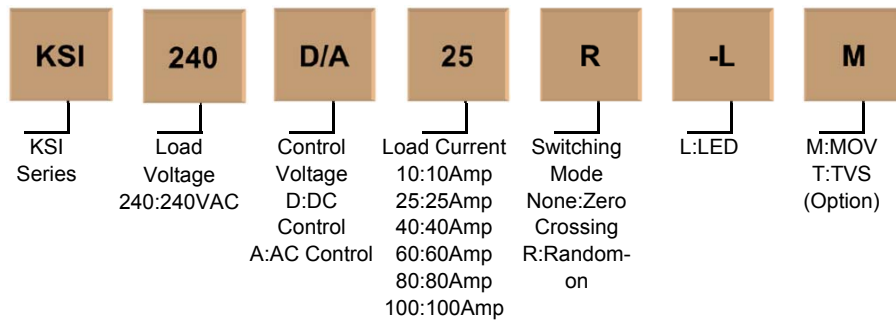

Description	10A	25A	40A	60A	80A	100A
D:4-32VDC	KSI240D10	KSI240D25	KSI240D40	KSI240D60	KSI240D80	KSI240D100
	KSI240D10R	KSI240D25R	KSI240D40R	KSI240D60R	KSI240D80R	KSI240D100R
AC:90-280VAC	KSI240A10	KSI240A25	KSI240A40	KSI240A60	KSI240A80	KSI240A100

Technical Specification

Input Circuit

Control Voltage Range	DC Input	4-32VDC
	AC Input	90-280VAC
Minimum Turn-On Voltage	DC Input	4VDC
	AC Input	90VAC
Minimum Turn-Off Voltage	DC Input	1VDC
	AC Input	10VAC
Maximum Input Current	DC Input	25mA
	AC Input	10mA

Output Circuit

Load Voltage Range	48-280VAC	
Maximum Turn-On Time	DC Input Random-On	1ms
	DC Input Zero-On	1/2AC Cycle + 1ms

Maximum Turn-Off Time	AC Input	20ms
	DC Input	1/2AC Cycle + 1ms
Maximum Surge Current [@10ms]	AC Input	40ms
	10A	150A
	25A	400A
	40A	440A
	60A	860A
	80A	1280A
Maximum I ² t For Fusing [@10ms]	100A	1550A
	10A	350A ² S
	25A	900A ² S
	40A	970A ² S
	60A	3698A ² S
	80A	8192A ² S
	100A	12012A ² S
	Transient Overvoltage	600Vpk
Maximum Off-State Leakage Current [@ Rated Voltage]		5mA
Maximum On-State Voltage Drop [@ Rated Current]		1.6Vrms
Minimum Off-State dv/dt [@ Maximum Rated Voltage]		500V/μs

General Information

Dielectric Strength[50/60Hz]	Input/Output	≥4000Vrms
	Output/Base	≥2500Vrms
Ambient Operating Temperature Range		-30°C ~ +80°C
Ambient Storage Temperature Range		-30°C ~ +100°C
Weight [typical]		85g

Application

High-low Temperature Chamber, Plastics Machinery, Incubation Machine, Oiling Machine, HVAC, Elevator, Lighting, Fountain Controller.

Installation

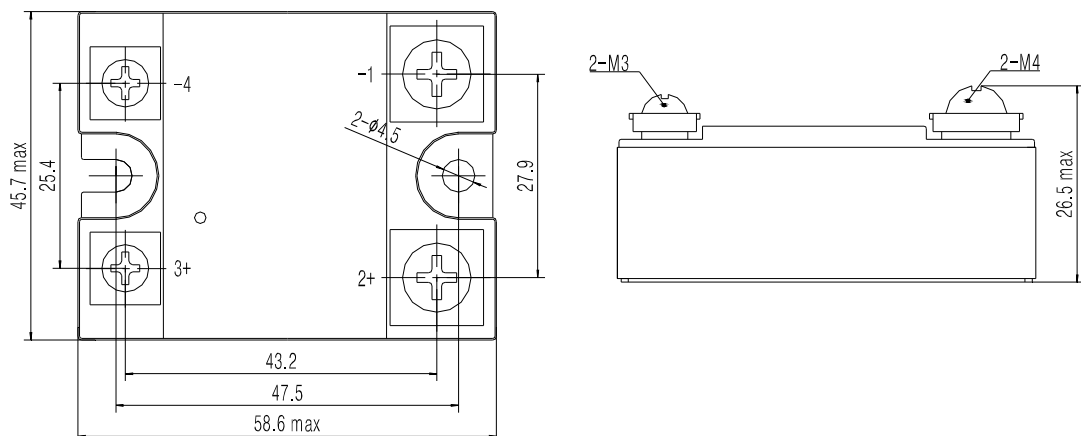

Thermal Curve

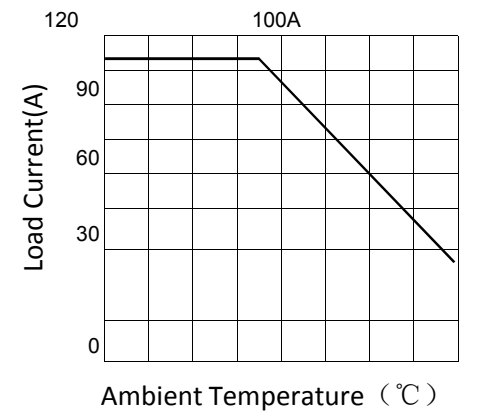
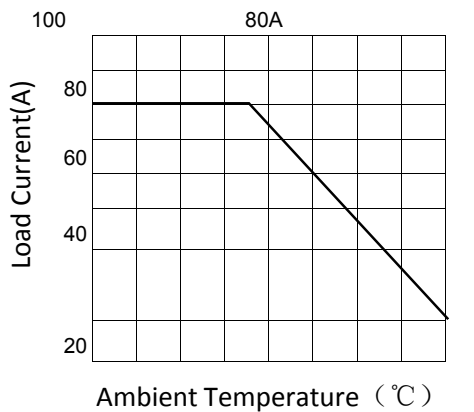
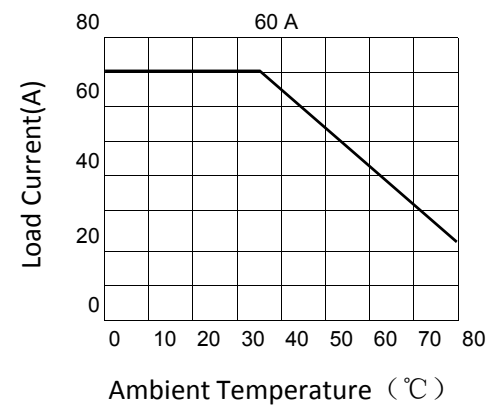
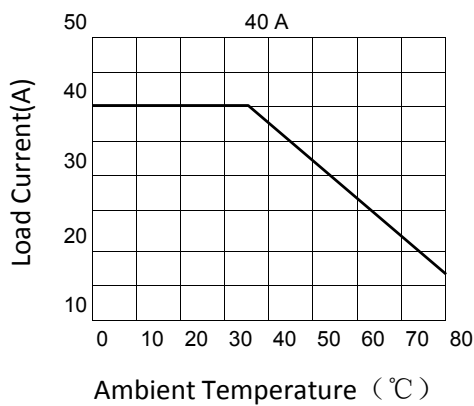
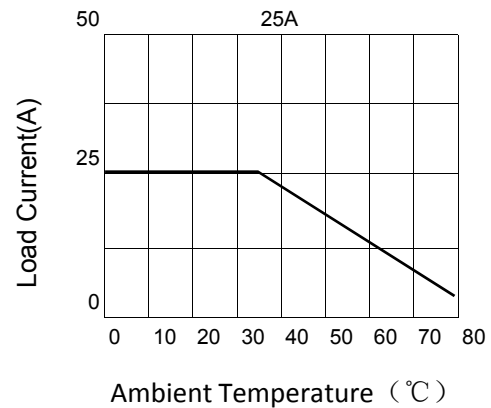
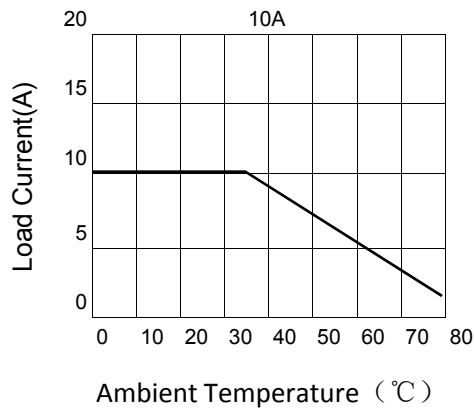

Important Notice

1. When the ambient temperature is over 40°C or many KSI series are installed closely together, the user should take load discount into account according to the thermal curve.
2. If the load current is over 10A, suitable heatsink should be added to the SSR.

Product Certification

