

- **High Surge Current Rectifier Circuits**
- **Up to 1600 Volt Blocking Standard**

Single- and three-phase diode circuits incorporate highly efficient thermal management to provide high surge capability, extended life, and reliable performance. Available in five circuits, all models come in an industry standard package, provide 2500 Vrms from all terminals to the baseplate, and are UL recognized (file no. E72445).

Manufactured in Crydom's ISO 9002 Certified facility for optimum product performance and reliability.

PART NUMBER IDENTIFICATION

Series Type	Current	Circuit Type	Voltage	
M50	60 - 60 Amps	(see schematic diagrams)	400 (120Vac)	1200 (480Vac)
	100 - 100 Amps	Example: TB	600 (240Vac)	1400 (530Vac)
			1000 (380Vac)	1600 (600Vac)

Example: M50 100TB1200

MECHANICAL DIMENSIONS

All dimensions are in inches (millimeters)

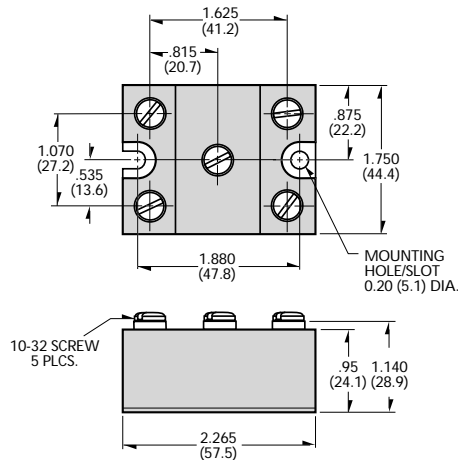

ELECTRICAL SPECIFICATIONS

SYMBOL SPECIFICATION

RATINGS

SYMBOL	SPECIFICATION	M5060	M50100
I_D	Maximum DC Output Current ($T_c = 85^\circ$)	60A	100A
V_F	Maximum Voltage Drop @ Amps Peak	1.35V @ 60A	1.2V @ 100A
T_J	Operating Junction Temperature Range	-40 $^\circ$ to +125 $^\circ$	
V_{RRM}	(Repetitive Peak Reverse Voltage (AC Line))	400 (120 Vac)	
		600 (240 Vac)	
		1000 (380 Vac)	
		1200 (480 Vac)	
		1600 (600 Vac)	
I_{TSM}	Maximum Non-Repetitive Surge Current (1/2 Cycle, 60Hz)	800A	1500A
I^2T	Maximum I^2T for Fusing ($t=8.3ms$) [A^2sec]	2650	9350
$R_{\theta JC}$	Maximum Thermal Resistance Junction to Ceramic Base per Chip	0.45 $^\circ$ /W	0.3 $^\circ$ /W
V_{ISOL}	Isolation Voltage	2500 V_{RMS}	2500 V_{RMS}

MECHANICAL SPECIFICATIONS

Weight: (typical) 4.5 oz. (158g)

©2003 CRYDOM CORP Specifications subject to change without notice.

- High Surge Current Rectifier Circuits
- Up to 1600 Volt Blocking Standard

PART NUMBER IDENTIFICATION

Series Type	Current	Circuit Type	Voltage	
M50	60 - 60 Amps	(see schematic diagrams)	400 (120Vac)	1200 (480Vac)
	100 - 100 Amps	Example: TB	600 (240Vac)	1400 (530Vac)
			1000 (380Vac)	1600 (600Vac)

Example: M50 100TB1200

M50 DIODE CIRCUITS

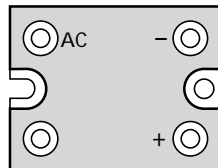
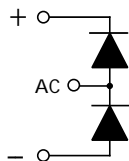
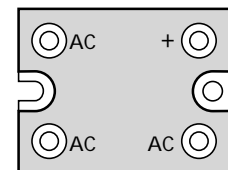
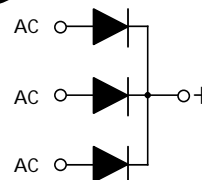
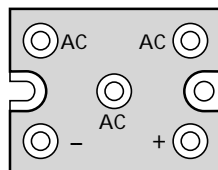
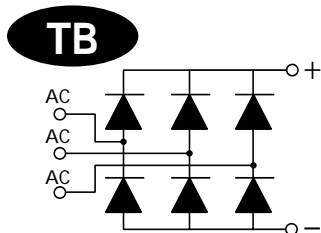
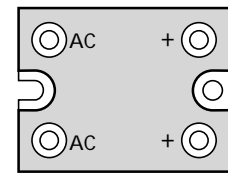
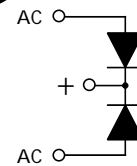
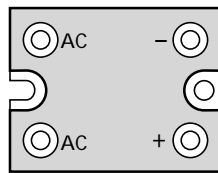
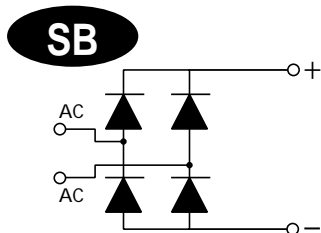

©2003 CRYDOM CORP Specifications subject to change without notice.